

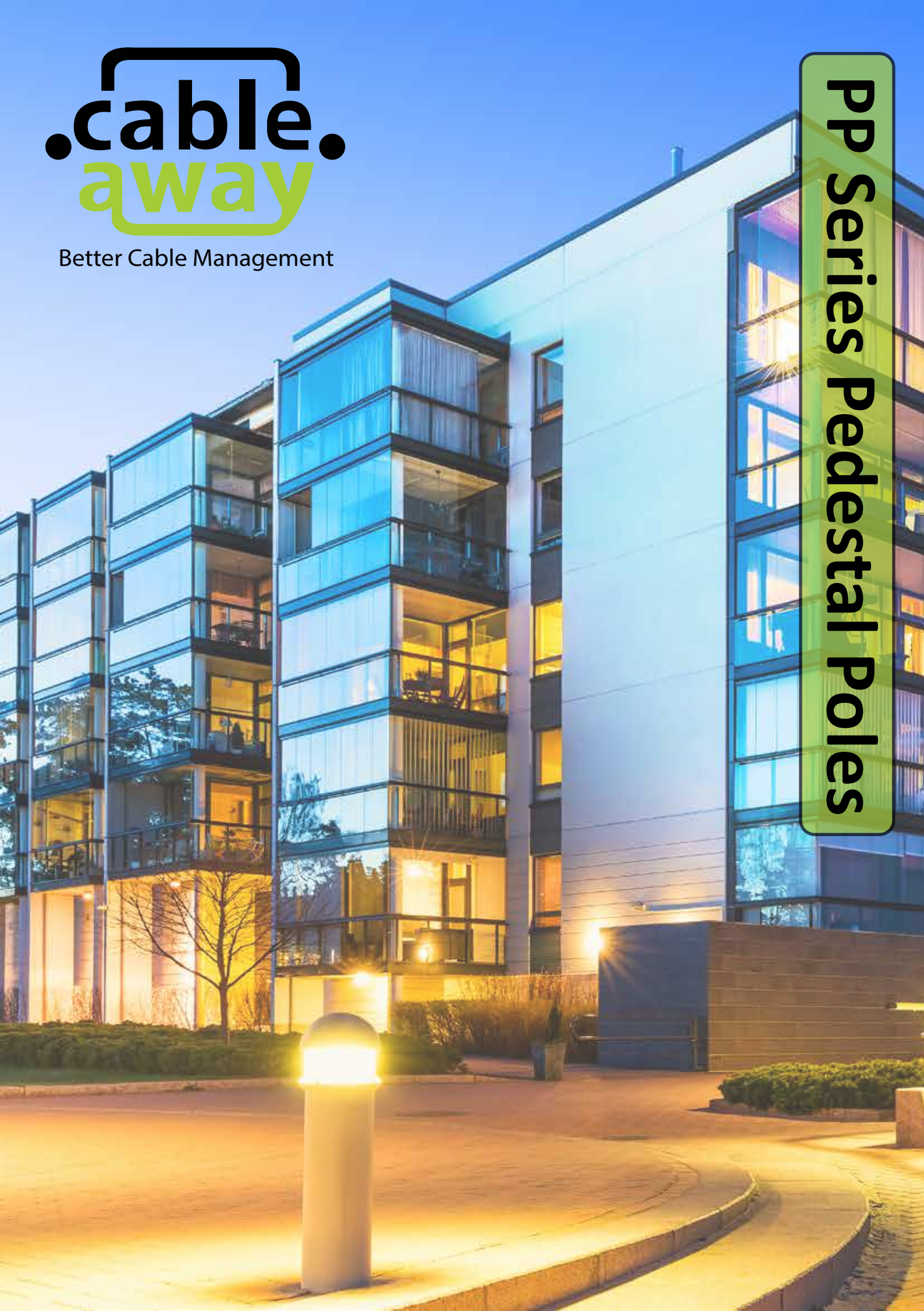

Better Cable Management

PP Series Pedestal Poles





Manage Cables Better

Cableaway's range of pedestal poles are a cost effective way to provide power, Data and Audio Visual outlets to above or below bench areas in office's, school's or laboratories (etc).

Cableaway's pedestals are mounted directly to any surface by using the 4 mounting holes provided. It could not be easier to mount your outlet's as all pedestal pole's come complete with mounting cut outs for standard outlets.

- Extruded aluminium body
- Welded aluminium base plate
- Removable top cap
- Pre-cut outlet mounting holes
- Made to any height requirement
- Powder coated finish
- Outlet mounting up to all 4 side's

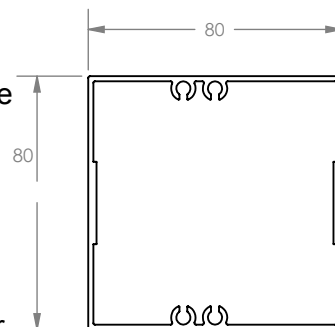
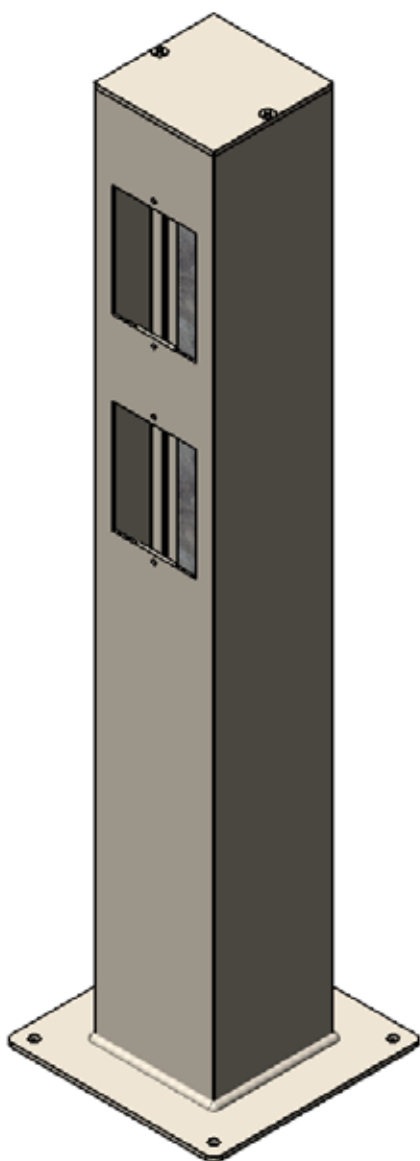

Single Division

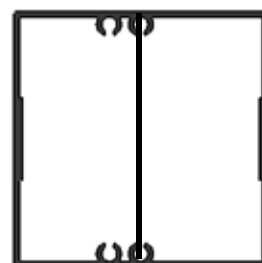

Two Division

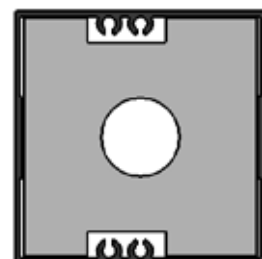

Horizontal Zoning

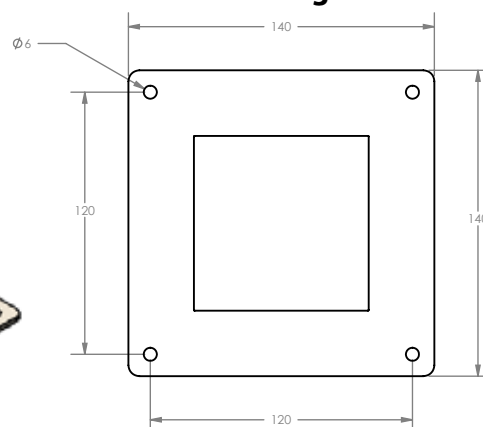

Foot Plate



Manage Cables Better

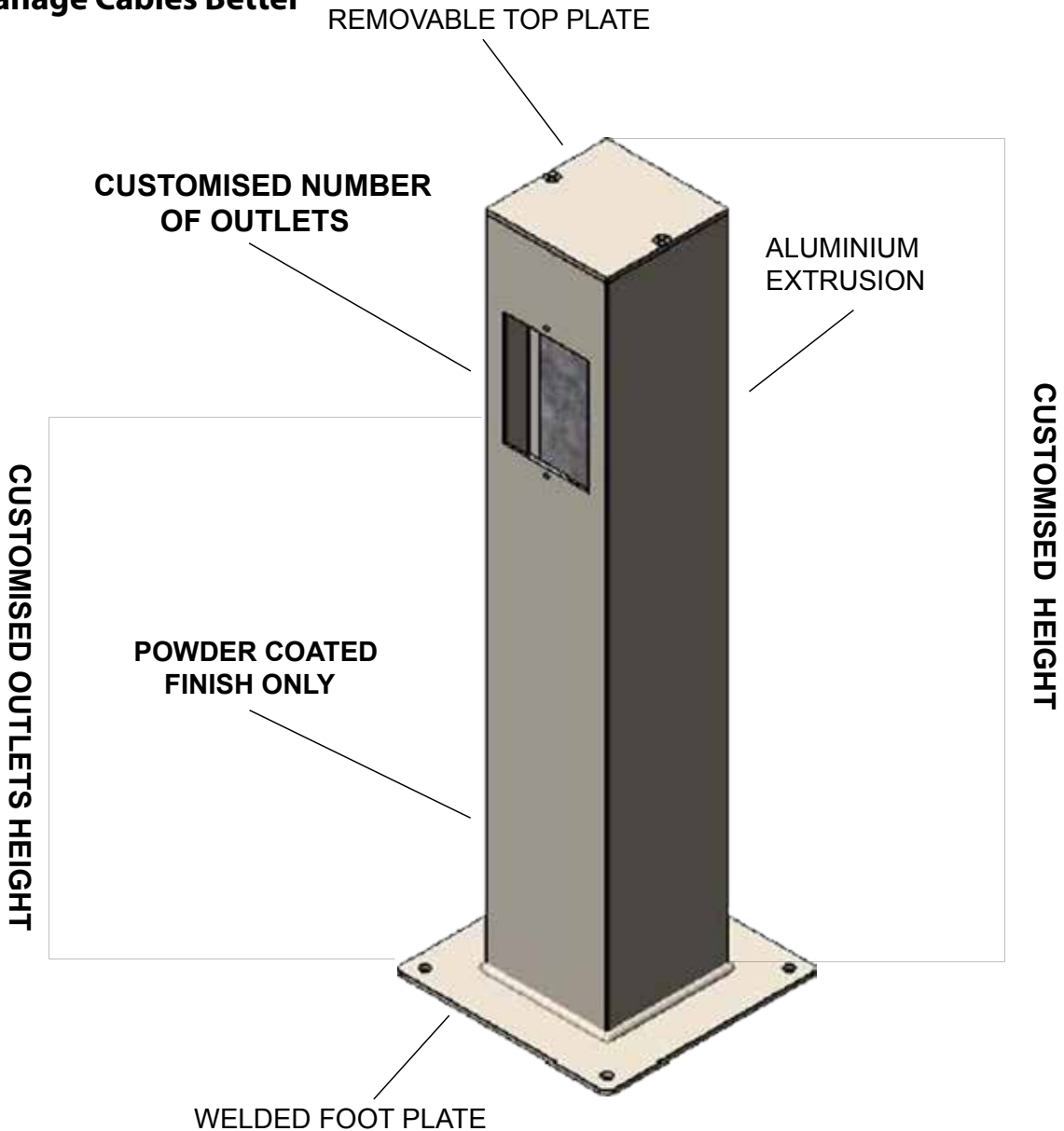

PP8080 SERIES PEDASTAL POLE

Suggested Specification:

Contractor shall use a Cableaway PP series pedastal pole to the nominated size (height). The construction of the pedastal pole shall be an aluminium extrusion complete with welded foot plate and divisional barrier dividing power and data. Colour of the pedastal pole to be nominated by Architect. Provision for Mounting of GPO and Data outlets to be nominated (height and amount of outlets) by electrical Consultant and cut outs to be completed by Cableaway.

Description

PP Series Pedastal Pole (number of outlets, height of pole and colour)

PP8080SPEC



Better Cable Management

Cableaway Pty Ltd

Unit 8, 15 McPherson Road, Smeaton Grange NSW 2567

ph: 02 8006 4244 fax: 02 4647 2050

www.cableaway.com.au