

PVC CABLE TRAY

PRODUCT TECHNICAL GUIDE

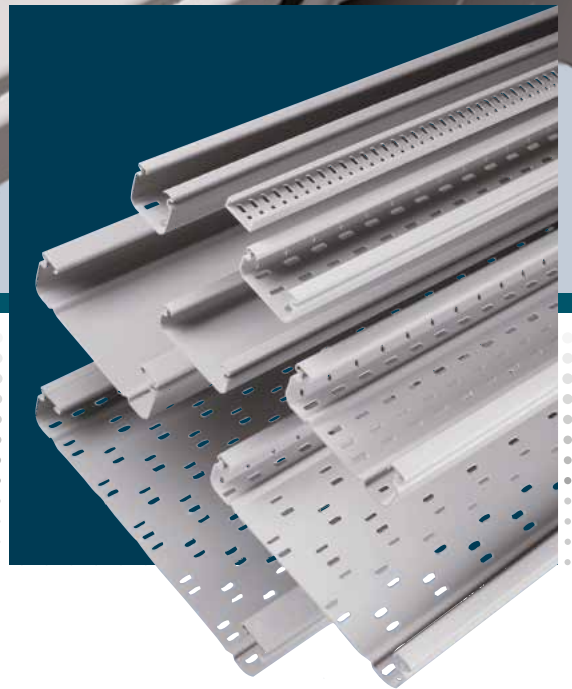

BETTER CABLE MANAGEMENT



INTRODUCTION

Features

Faster by Design

PRODUCT AND TECHNICAL INFORMATION

PVC cable tray

Covers and couplers

Fittings

Supports and accessories

Resistance to chemical agents

PVC CABLE TRAY

resistance to damp and corrosion

no thermal stress

THE IDEAL CHOICE FOR DAMP AND CORROSIVE ENVIRONMENTS

- PVC cable tray does not conduct electricity. There is therefore no earthing requirement.
- The operating temperature range is from -20°C to + 60°C.
- Conforms to the RoHS Directive.

EXCELLENT RESISTANCE

PVC is corrosion-free with excellent resistance to chemical agents and damp environments, giving it a long service life.

IMPACT RESISTANCE

It has high resistance of up to 20 J, depending on the size.

NON-FLAMMABLE, SELF-EXTINGUISHING

PVC is flame retardant and has excellent resistance to fire (Class M1).

EASY TO INSTALL

PVC cable tray is lightweight to handle and transport. It is easy to cut, perforate or join together, and causes little damage to cables or injury to hands.

A COMPLETE SYSTEM

Available in a standard or reinforced version with a perforated or unperforated base.





ECO - FRIENDLY

PVC is a 100% recyclable material, both physically and chemically.

The PVC cable tray range complies with the requirements of the RoHS Directive, which stipulates the elimination of several substances that are hazardous to the environment and to health.

PVC requires very little energy during its manufacture. The table below shows the overall energy balance (raw materials + energy) for PVC and other materials expressed in MJ per kg:

PVC 59	PP 73	PS 80	PET 84	Aluminium 200
--------	-------	-------	--------	------------------

PVC: Polyvinyl chloride, PP: Polypropylene, PS: Polystyrene, PET: Polyethylene terephthalate

COMPLETE RANGE OF INNOVATIVE ACCESSORIES

The thermoformed fittings with integrated couplers can be used to create specific configurations.

A consistent 150 mm radius of curvature helps prevent critical cables from being damaged and allows them to slide through the tray easily. The covers simply clip on, and lengths can be fixed to the wall or suspended from ceilings.

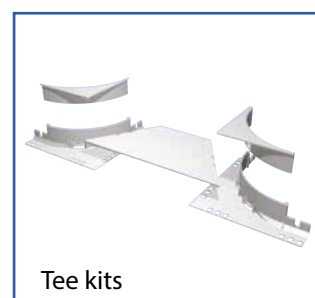

PVC CABLE TRAY

FASTER BY DESIGN



Three simple steps to better cable management...

We continually look for ways to improve our product ranges. In the case of cable management, every improvement we make has the installer in mind and is based around the three areas that make up our 'Faster by Design' ethos:

1

EASIER TO INSTALL

2

FASTER TO INSTALL

3

FEWER COMPONENTS

Our products are not only faster to install, they're also easier to handle and require less time on site to fit - reducing the total installed cost of your project.

1 EASIER TO INSTALL

Multifunction brackets

Multifunction brackets can be used in a wide range of applications by simply changing the orientation of the bracket for wall or ceiling, or changing the fixing position to be fixed to channel. Applications include:

- Wall mounting
- Ceiling mounting
- Part of a wider support system

Rapid fix rivets

- Rapid fix rivets can be used to secure PVC tray to brackets without the need for any tools, just simply place and press the rivet and the tray is secured.
- The rivets have specifically designed fins for easier installation and strength.

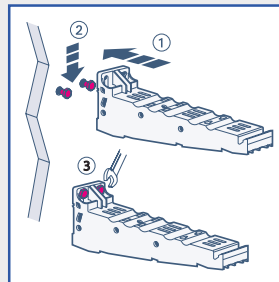

Process of fixing the multifunction bracket to a wall

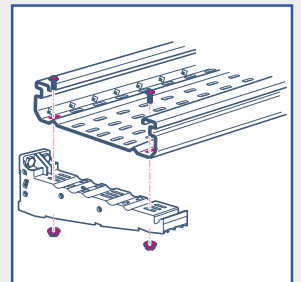

Fixing a length to the multifunction bracket using rapid fit rivets

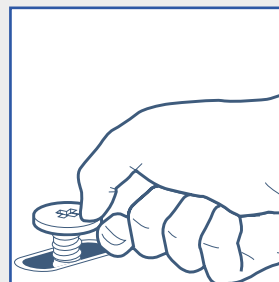

Place the rivet



Press and it's fixed

Features that simplify installation and save time

2 FASTER TO INSTALL

Coupler

Allows lengths to be clipped together without any additional fittings, making coupling quick and easy with no need for fasteners.

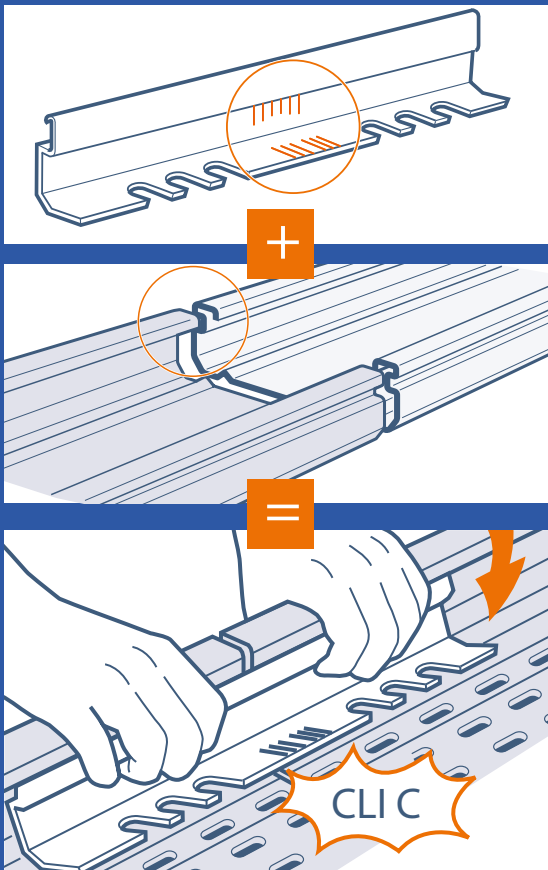

Clip on covers

Covers can simply be hooked and stored on the bracket during installation.

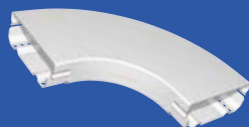

SIGNIFICANT ADVANTAGES

Optimised design of lengths:

- Enhanced cabling capacity
- Time-saving as couplers and covers simply clip on
- High mechanical strength

3 FEWER COMPONENTS

Fewer fittings

All part numbers now come with covers

No special tees required

Compact and easy to adapt tee kits allow for easier fitting on site

Built-in coupler

All thermoformed fittings have integrated couplers



Tee intersections



Tee kit

PVC cable tray

perforated tray

50 → 100 mm

75 → 600 mm

3 m

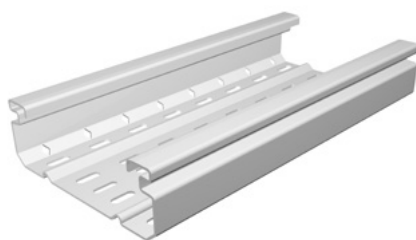

6379 11

PVC cable tray

unperforated tray

50 → 100 mm

75 → 600 mm

3 m

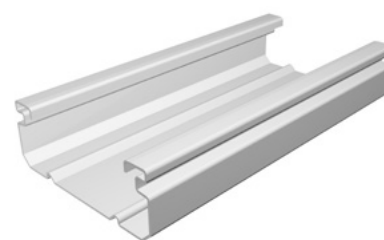

6379 10

Pack	Cat. Nos.	PVC cable tray	
		Conform to BS EN 61537	
		Length 3 m	
		Width x Depth (mm)	
			Width (mm)
6	6377 01	75 x 50	75
6	6377 11	100 x 50	100
6	6377 21	150 x 50	150
6	6377 31	200 x 50	200
6	6377 41	300 x 50	300
6	6377 51	400 x 50	400
6	6378 01	75 x 75	75
6	6378 11	100 x 75	100
6	6378 21	150 x 75	150
6	6378 31	200 x 75	200
6	6378 41	300 x 75	300
6	6378 51	400 x 75	400
6	6379 01	200 x 100	200
6	6379 11	300 x 100	300
6	6379 21	400 x 100	400
6	6379 31	500 x 100	500
6	6379 41	600 x 100	600

Pack	Cat. Nos.	PVC cable tray	
		Conform to BS EN 61537	
		Length 3 m	
		Width x Depth (mm)	
			Width (mm)
6	6377 00	75 x 50	75
6	6377 10	100 x 50	100
6	6377 20	150 x 50	150
6	6377 30	200 x 50	200
6	6377 40	300 x 50	300
6	6377 50	400 x 50	400
6	6378 00	75 x 75	75
6	6378 10	100 x 75	100
6	6378 20	150 x 75	150
6	6378 30	200 x 75	200
6	6378 40	300 x 75	300
6	6378 50	400 x 75	400
6	6379 00	200 x 100	200
6	6379 10	300 x 100	300
6	6379 20	400 x 100	400
6	6379 30	500 x 100	500
6	6379 40	600 x 100	600

PVC cable tray

technical information

PVC perforated cable tray

Dimensions

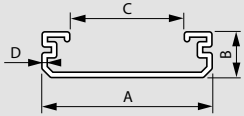

6377 01	75	50	32.4	2-3	2 862	3 000
6377 11	100	50	57	2-3	4 055	3 000
6377 21	150	50.2	106.6	2-6	6 366	3 000
6378 01	75	75	32	2-3	4 622	3 000
6378 11	100	75	57	2-3	6 440	3 000
6378 21	150	75.3	106.2	2-7	9 961	3 000

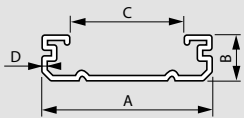

6377 31	200	50	136.6	2-5	7 934	3 000
6377 41	300	52	232.6	3-5	12 825	3 000
6377 51	400	53	330.6	4	17 821	3 000
6378 31	200	75	138.8	2-8	12 690	3 000
6378 41	300	77	234.4	3-8	19 601	3 000
6378 51	400	77.8	332.8	4-2	26 879	3 000
6379 01	200	100	130	3-8	16 979	3 000
6379 11	300	100.4	210	4	26 728	3 000
6379 21	400	101.4	300	4-5	36 468	3 000
6379 31	500	101.4	370	4-5	45 893	3 000
6379 41	600	102	470	4-8	55 206	3 000

PVC unperforated cable tray

Dimensions

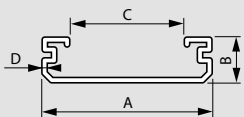

6377 00	75	50	32.4	2-3	2 862	3 000
6377 10	100	50	57	2-3	4 055	3 000
6377 20	150	50.2	106.6	2-6	6 366	3 000
6378 00	75	75	32	2-3	4 622	3 000
6378 10	100	75	57	2-3	6 440	3 000
6378 20	150	75.3	106.2	2-7	9 961	3 000

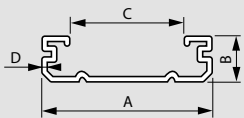

6377 30	200	50	136.6	2-5	7 934	3 000
6377 40	300	52	232.6	3-5	12 825	3 000
6377 50	400	53	330.6	4	17 821	3 000
6378 30	200	75	138.8	2-8	12 690	3 000
6378 40	300	77	234.4	3-8	19 601	3 000
6378 50	400	77.8	332.8	4-2	26 879	3 000
6379 00	200	100	130	3-8	16 979	3 000
6379 10	300	100.4	210	4	26 728	3 000
6379 20	400	101.4	300	4-5	36 468	3 000
6379 30	500	101.4	370	4-5	45 893	3 000
6379 40	600	102	470	4-8	55 206	3 000

Perforation details

Width 75 mm

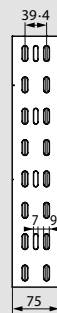

Width 100 mm

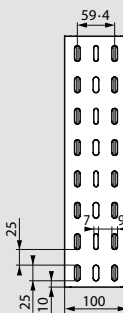

Width 150 mm

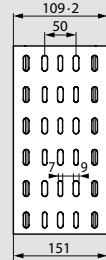

Width 200 mm

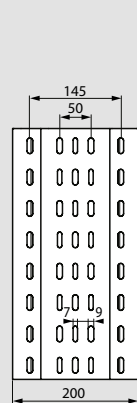

Width 300 mm

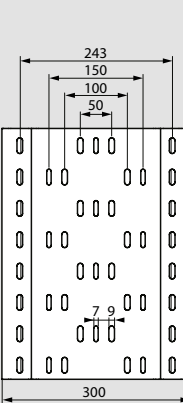

Width 400 mm

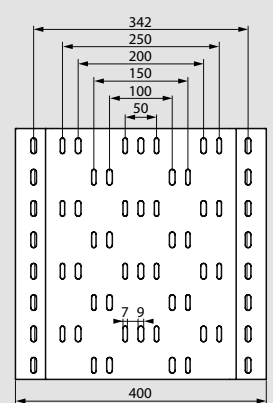

Width 500 mm

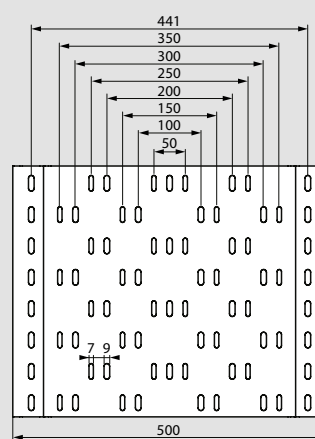

Width 600 mm

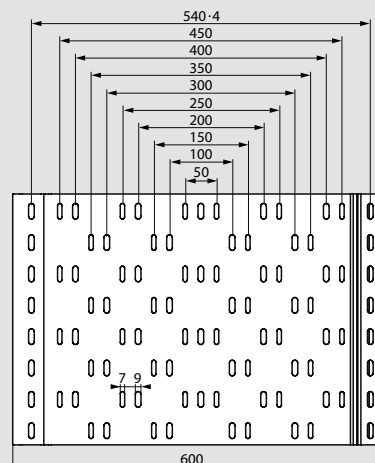

PVC cable tray

technical information (continued)

Cable loading information

The table below gives safe working loads (SWL) in N/m. SWL are acceptable up to 40 °C for spans of 1 - 5 m and 60 °C for spans of 1 m, on the European test standard

75	7	12	-
100	10	16	-
150	15.5	25	-
200	19.5	35	42
300	27	48	66
400	41	70	90
500	-	-	113
600	-	-	135.5

Safe working load test

The test for cable loading conforms to BS EN 61537 test type 1

The following conditions apply to the test as shown in diagram below

1. The cable tray is supported at 1.5 m spans and not fixed to supports during tests
2. The coupler joint is at the centre of support A - B
3. The fixing torque for coupler bolts is 2.5 N/m
4. The test load is a uniform distributed load (UDL) over the test area of 2 spans and cantilever
5. The longitudinal deflection on a span is limited to the span length divided by 100
6. The transversal deflection reached in the centre of the cable tray bed is limited to bed width divided by 20

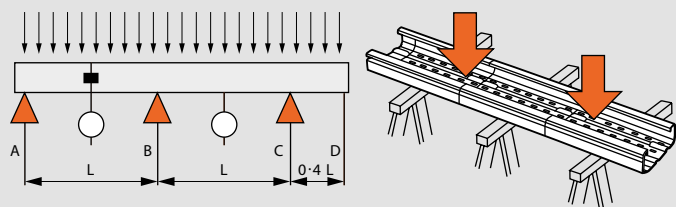

Design of the lengths

Width 75 to 150 mm



Totally flat profile, optimising the cabling capacity

Width 200 to 600 mm

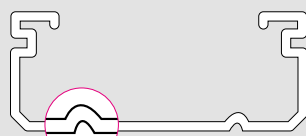

With 2 ribs on the base to take higher loads

Base perforations

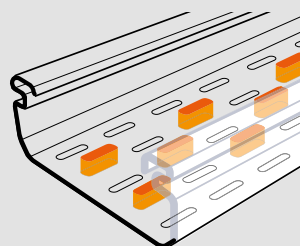

9 x 25 mm perforations for PVC screws - diameter 8 mm

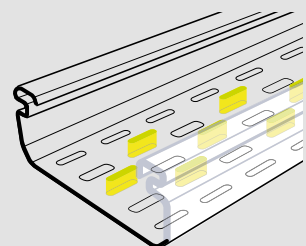

7 x 25 mm perforations for PVC screws - diameter 6 mm

Clipping lengths together

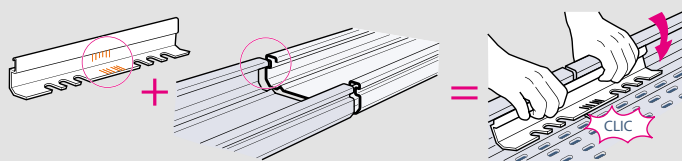

Marking system for installing couplers according to temperature conditions (to enable the PVC to expand)

Resistance to impacts

The products are tested at -5 °C temperature according to EN 61537 standard

75	5 J	5 J	-
100	5 J	10 J	-
150	10 J / 20 J ¹	10 J / 20 J ¹	-
200	10 J	20 J	20 J
300	10 J	20 J	20 J
400	10 J	20 J	20 J
500	-	-	20 J
600	-	-	20 J

1 : Unperforated

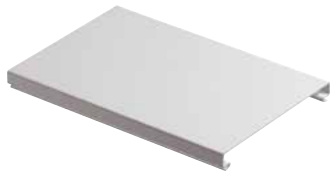
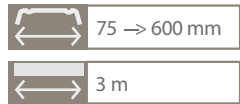

6379 64



6377 91

Pack	Cat. Nos.	Covers
		Width (mm)
24	6377 60	75
24	6377 61	100
18	6377 62	150
12	6377 63	200
12	6377 64	300
12	6377 65	400
12	6379 63	500
12	6379 64	600

Pack	Cat. Nos.	Couplers
		Couplers (mm)
20	6377 90	For 75 to 150 x 50
20	6377 91	For 200 to 400 x 50
20	6378 90	For 75 to 150 x 75
20	6378 91	For 200 to 400 x 75
20	6379 90	For 200 to 600 x 100
		Hinged couplers (mm)
20	6377 93	For width 75 to 150
20	6379 93	For width 200 to 600

Covers

Dimensions

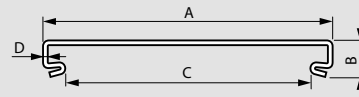

75	15-6	56-6	1-2	3 000
100	15-6	81-6	1-2	3 000
150	15-9	131-6	1-5	3 000
200	23-9	171-6	2	3 000
300	25-3	271-6	2-5	3 000
400	25-3	371-6	2-5	3 000
500	28-1	471-6	2-8	3 000
600	28-1	571-6	2-8	3 000

Couplers

Dimensions

Cat. Nos. 6377 90 and 6378 90

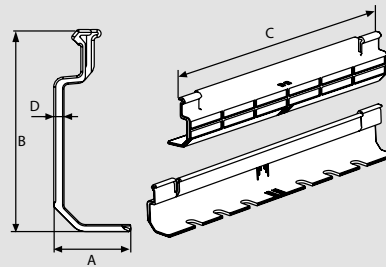

50	27	45-9	275	3-6
75	27	70-9	275	3-6

Fixing



Cat. Nos. 6377 91, 6378 91 and 6379 90

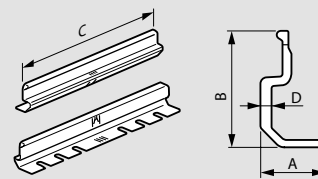

50	38-3	45-4	300	5
75	38-8	69-8	350	7-5
100	38-8	92-8	450	7-5

Fixing



Hinged Cat. Nos. 6377 93 and 6379 93

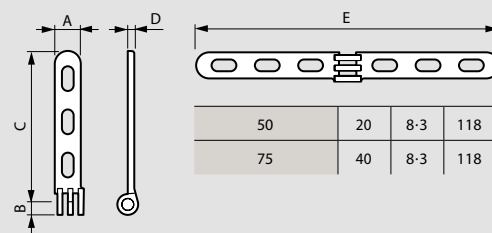

50	20	8-3	118	5	244-3
75	40	8-3	118	5	244-3



6377 13



6378 60

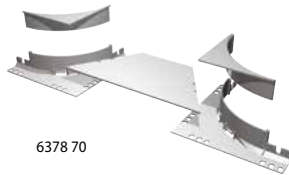

6378 70

Pack	Cat. Nos.	Flat 90° bends
		Supplied with covers
		Width x Depth (mm)
4	6377 03	For 75 x 50
4	6377 13	For 100 x 50
4	6377 23	For 150 x 50
2	6377 33	For 200 x 50
2	6377 43	For 300 x 50
1	6377 53	For 400 x 50
4	6378 03	For 75 x 75
4	6378 13	For 100 x 75
4	6378 23	For 150 x 75
2	6378 33	For 200 x 75
2	6378 43	For 300 x 75
1	6378 53	For 400 x 75
1	6379 03	For 200 x 100
1	6379 13	For 300 x 100
1	6379 23	For 400 x 100
1	6379 33	For 500 x 100
1	6379 43	For 600 x 100

Pack	Cat. Nos.	Tee intersections
		Width (mm)
2	6378 60	For 75 and 50
2	6379 60	For 100

Pack	Cat. Nos.	Tee kits
		Width x Depth (mm)
4	6378 70	For 75 x 50/75
2	6378 71	For 100 x 50/75
2	6378 72	For 150 x 50/75
3	6378 73	For 200 x 50/75
1	6378 74	For 300 x 50/75
1	6378 75	For 400 x 50/75
1	6379 70	For 200 x 100
1	6379 71	For 300 x 100
1	6379 72	For 400 x 100
1	6379 73	For 500 x 100
1	6379 74	For 600 x 100

Flat 90° bends

Dimensions and fixing

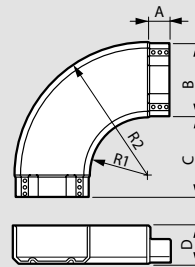

Fixing

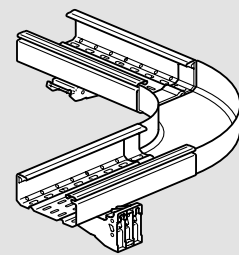

75	52	68	210	150	224
100	52	93	210	150	249
150	52	142	210	150	298
200	52	196	210	150	346
300	52	289	210	150	445
400	52	388	210	150	544
500	52	488	210	150	644
600	52	587	210	150	743

D = 50, 75 or 98 mm

Tee kits

Dimensions and fixing

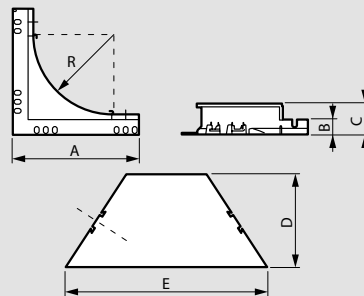

75	237	28	164	233	150
100	237	28	164	260	150
150	237	28	164	310	150
200	237	28	164	362	150
300	237	28	164	461	150
400	237	28	164	556	150
500	237	28	164	659	150
600	237	28	164	756	150

C = 53 for 50 and 75 mm depth trays
C = 78 for 100 mm depth trays

Installation

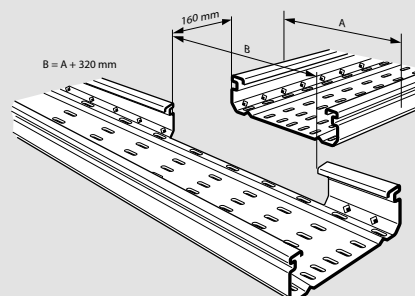

A = width of tray
B = required cut-out

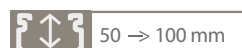

50 → 100 mm



75 → 600 mm



6377 15



6377 17

Pack	Cat. Nos.	Inside 90° risers
		Supplied with covers
		Width x Depth (mm)
		PVC
4	6377 05	For 75 x 50
4	6377 15	For 100 x 50
4	6377 25	For 150 x 50
2	6377 35	For 200 x 50
2	6377 45	For 300 x 50
1	6377 55	For 400 x 50
4	6378 05	For 75 x 75
4	6378 15	For 100 x 75
4	6378 25	For 150 x 75
2	6378 35	For 200 x 75
2	6378 45	For 300 x 75
1	6378 55	For 400 x 75
1	6379 05	For 200 x 100
1	6379 15	For 300 x 100
1	6379 25	For 400 x 100
1	6379 35	For 500 x 100
1	6379 45	For 600 x 100

Pack	Cat. Nos.	Outside 90° risers
		Supplied with covers
		Width x Depth (mm)
		PVC
4	6377 07	For 75 x 50
4	6377 17	For 100 x 50
4	6377 27	For 150 x 50
2	6377 37	For 200 x 50
2	6377 47	For 300 x 50
1	6377 57	For 400 x 50
4	6378 07	For 75 x 75
4	6378 17	For 100 x 75
4	6378 27	For 150 x 75
2	6378 37	For 200 x 75
2	6378 47	For 300 x 75
1	6378 57	For 400 x 75
1	6379 07	For 200 x 100
1	6379 17	For 300 x 100
1	6379 27	For 400 x 100
1	6379 37	For 500 x 100
1	6379 47	For 600 x 100

■ Inside 90° risers

Dimensions and fixing

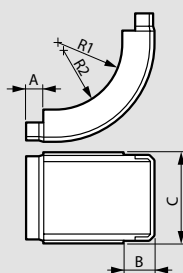

Fixing

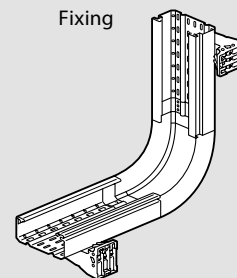

Width (mm)	A (mm)	C (mm)	R1 (mm)	R2 (mm)
75	52	68	150	200
100	52	93	150	200
150	52	142	150	200
200	52	190	150	200
300	52	289	150	200
400	52	388	150	200
500	52	488	150	200
600	52	587	150	200

■ Outside 90° risers

Dimensions and fixing

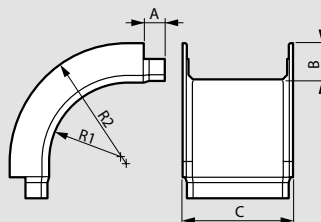

Fixing

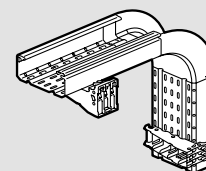

Width (mm)	A (mm)	C (mm)	R1 (mm)	R2 (mm)
75	52	68	150	200
100	52	93	150	200
150	52	142	150	200
200	52	190	150	200
300	52	289	150	200
400	52	388	150	200
500	52	488	150	200
600	52	587	150	200

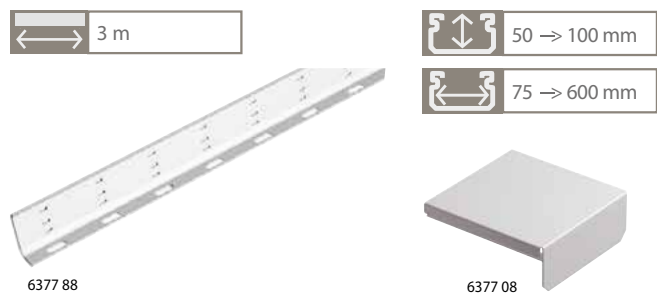

Pack	Cat. Nos.	Dividers
		Depth (mm)
42	6377 88	50
30	6378 88	75
24	6379 88	100

		End caps
		Width x Depth (mm)
2	6377 08	For 75 x 50
2	6377 18	For 100 x 50
2	6377 28	For 150 x 50
2	6377 38	For 200 x 50
2	6377 48	For 300 x 50
2	6377 58	For 400 x 50
2	6378 08	For 75 x 75
2	6378 18	For 100 x 75
2	6378 28	For 150 x 75
2	6378 38	For 200 x 75
2	6378 48	For 300 x 75
2	6378 58	For 400 x 75
2	6379 08	For 200 x 100
2	6379 18	For 300 x 100
2	6379 28	For 400 x 100
2	6379 38	For 500 x 100
2	6379 48	For 600 x 100

Dividers

Dimensions

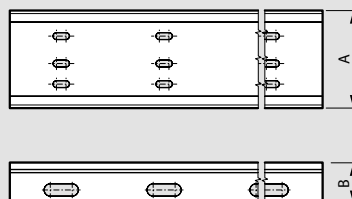

50	46-46	30	3 000
75	71-56	30	3 000
100	95-16	30	3 000

End caps

Dimensions

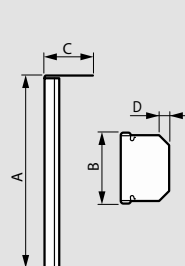

Depth 50 mm

75	200	51	11
100	200	51	11
150	200	52	11
200	200	52	13
300	200	54	14
400	200	55	15

Depth 75 mm

75	200	76	11
100	200	76	11
150	200	77	11
200	200	77	13
300	200	79	14
400	200	80	15

Depth 100 mm

200	200	102	15
300	200	104	15
400	200	104	15
500	200	104	15
300	200	105	16



75 → 300 mm

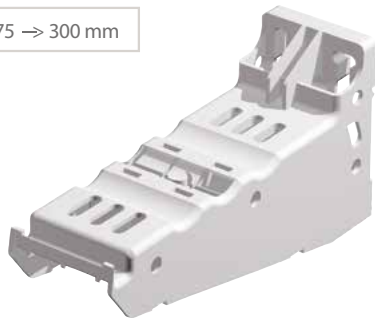

6377 69



300 → 600 mm

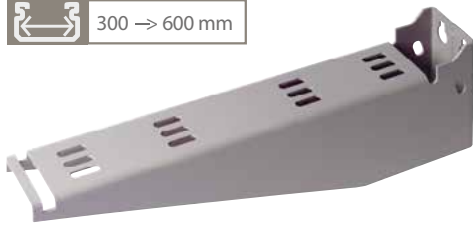

6379 78

Pack	Cat. Nos.	Cantilever arms - PVC
		Compatible with metal support
		Width (mm)
8	6377 66	For 75/100
6	6377 67	For 150
4	6377 68	For 200
4	6377 69	For 300

Pack	Cat. Nos.	Cantilever arms - Plastic coated
		Width (mm)
2	6379 78	For 300
2	6379 79	For 400
2	6379 80	For 500
2	6379 81	For 600

Cantilever arms

PVC dimensions and fixing information

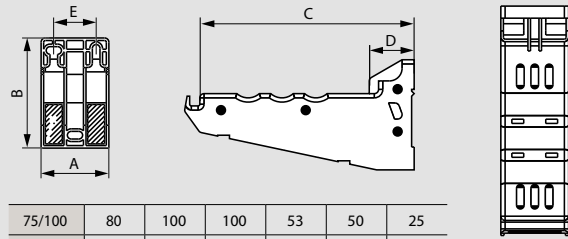

75/100	80	100	100	53	50	25
150	80	100	150	53	50	40
200	80	130	200	53	50	65
300	80	130	300	53	50	75

Plastic coated dimensions and fixing information

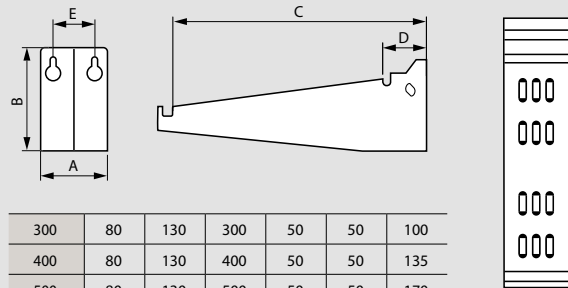

300	80	130	300	50	50	100
400	80	130	400	50	50	135
500	80	130	500	50	50	170
600	80	130	600	50	50	205

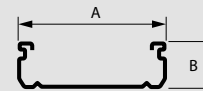

A x B (mm)		Load (N)	A x B (mm)		Load (N)
75 x 50		25	300 x 50		100
75 x 75			300 x 75		
100 x 50			300 x 100		
100 x 75			400 x 50		
100 x 50	6377 67	40	400 x 75	6379 79	135
100 x 75			400 x 100		
200 x 50					
200 x 75	6377 68	65	500 x 100	6379 80	170
200 x 100					
300 x 50					
300 x 75	6377 69	75	600 x 100	6379 81	205
300 x 100					

Wall mounting

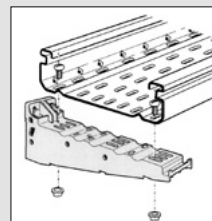

Ceiling installation for 200 and 300 mm widths only

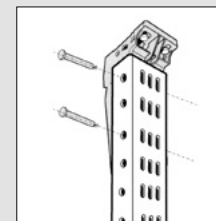



6377 75



6377 85

Pack	Cat. Nos.	Trapeze hangers
		Width (mm)
8	6377 71	For 75/100
6	6377 72	For 150
4	6377 73	For 200
4	6377 74	For 300
4	6377 75	For 400
4	6379 76	For 500
4	6379 77	For 600

Pack	Cat. Nos.	Stand-off brackets
		Width (mm)
8	6377 81	For 75/100
6	6377 82	For 150
4	6377 83	For 200
4	6377 84	For 300
4	6377 85	For 400
4	6379 83	For 500
4	6379 84	For 600

Trapeze hangers

Dimensions

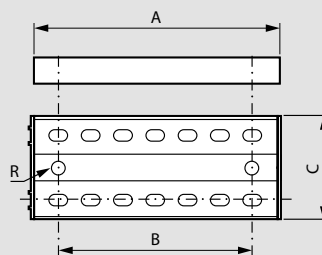

75/100	147	115	80	5	25
150	197	165	80	5	40
200	274	215	80	5	65
300	347	315	80	5	100
400	447	415	80	5	135
500	547	515	80	5	170
600	647	615	80	5	205

Stand-off brackets

Dimensions

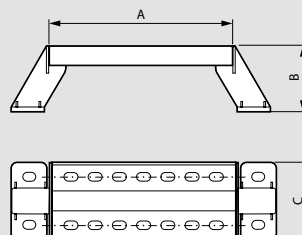

75/100	100	75	80
150	150	75	80
200	200	75	80
300	300	75	80
400	400	75	80
500	500	75	80
600	600	75	80



6379 85



6379 86



6379 55



6379 54

Pack	Cat. Nos.	
	PVC	Plastic coated
8	6379 55	-
6	-	6379 85
8	6379 50	6379 86
100	6379 51	-
50	-	6379 52

Accessories

- Ceiling bracket
- Ceiling bracket
- 2 m pendant channels
- M8 fixing pin
- M8 fixing pin

Pack	Cat. Nos.	
100	6379 53	PVC M8 x 20
100	6379 87	Stainless steel M8 x 20
		Rapid fix rivet
100	6379 54	Rivet

Fixings

- Fasteners
- PVC M8 x 20
- Stainless steel M8 x 20
- Rapid fix rivet
- Rivet

Accessories

Ceiling bracket

PVC ceiling bracket Cat. No. 6379 55

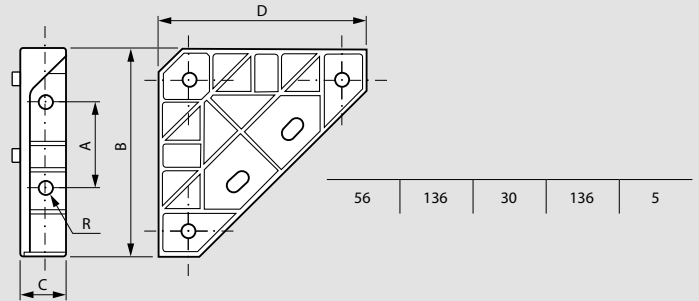

Plastic coated ceiling bracket Cat. No. 6379 85

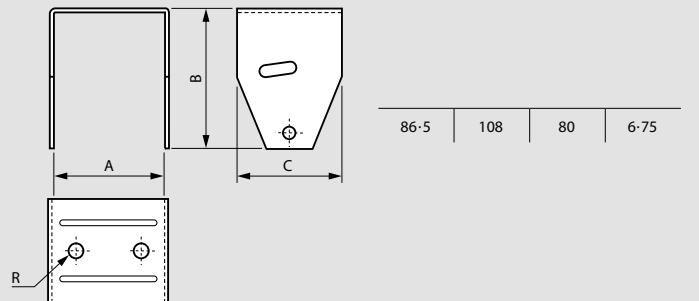

Pendant channel Cat. Nos. 6379 50 and 6379 86

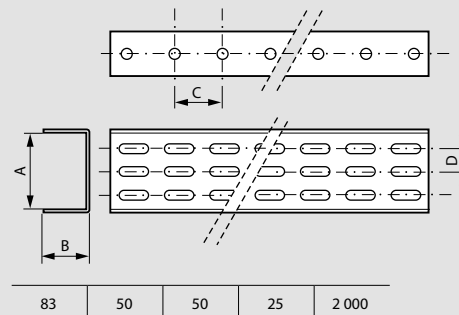

PVC M8 fixing pin Cat. No. 6379 51

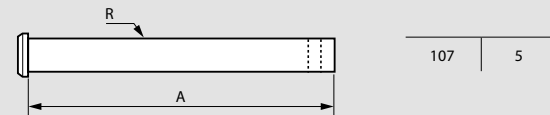

Plastic coated M8 fixing pin Cat. No. 6379 52

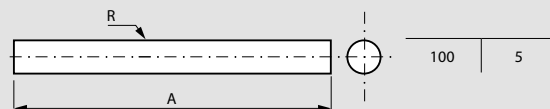

The properties stated below are purely for technical information, being based on common experience as well as the average tests carried out. They do not entail any responsibility on the part of the manufacturer.

results obtained from

Chemical agents	Concentration %	Temperature °C	PVC resistance ¹	Chemical agents	Concentration %	Temperature °C	PVC resistance ¹
Acetaldehyde	100	20	N	Carbon disulphide	100	20	M
Acetaldehyde, water solution	40	40	M	Carbon tetrachloride	100/100	20/60	N/N
Acetic acid, anhydride	100/100	20/60	N/N	Caustic soda solution (soda lime, sodium)	up to 40/ up to 40/50	40/60/60	R/M/R
Acetic acid, glacial	100/100	2 / 40	M/N	Chloramine, water solution	dilute	20	R
Acetic acid, water solution	up to 25/up to 25 25/60/80	40/60 60/40	R/M R/M	Chloric acid, water solution	1/1	40/60	R/R
Acetone	100	20	N	Chlorine, gaseous, dry	100	20	M
Acetone, water solution	trace	20	N	Chlorine, gaseous, moist	0.5/1-0	20/20	R/M
Acetylene gaseous, dry and moist	100	20	M	Chlorine water	saturated	20	M
Acrylic acid ethyl ester	100	20	N	Chloroacetic acid (moni)	100/100	40/60	R/M
Aluminium, all kinds, water solution	dilute/dilute/saturated (k)	40/60/60	R/M/R	Chloroform	100	20	N
Aluminium chloride, water solution	dilute/dilute/saturated (k)	40/60/60	R/M/R	Chlorosulphonic acid	100	20	M
Aluminium sulphate, water solution	dilute/dilute/saturated (k)	40/60/60	R/M/R	Chromic acid/sulphate acid/water	50/15/35	15/40	R
Ammonia, caustic	saturated/saturated	40/60	R/M	Chromic acid, water solution	80/80	20/60	R/M
Ammonia, gaseous	100	60	R	Citric acid, water solution	up to 10/up to 10/saturated (k)	40/60/60	R/M/R
Ammonia, liquid	100	20	M	Copper sulphate, water solution	dilute/dilute/saturated (k)	40/60/60	R/M/R
Ammonium chloride, water solution	dilute/dilute	40/60	R/M	Cresol, water solution	up to 90	45	R
Ammonium nitrate, water solution	dilute/dilute/saturated (k)	40/60/60	R/M/R	Crotonaldehyde	100	20	N
Ammonium sulphate, water solution	dilute/dilute/saturated (k)	40/60/60	R/R/R	Cyclohexanol	100	20	N
Amyl alcohol	96	20	M	Cyclohexanone	100	20	N
Aniline, pure	100	20	N	Dextrin, water solution	saturated/18	20/60	R/M
Aniline, water solution	saturated	20	N	Dichromate sulphuric acid (cleaning agent)	normal/service conc.	20/50	M/N
Aqua regia (hydrochloric + nitric acid)	normal service conc.	20	M	Diesel oil	100	20	R
Art. Fertiliser salts, water solution	saturated (k)	60	R	Dimethylamine	100	30	M
Beer	-	20	R	Ethereal oils	100	60	R
Benzaldehyde	0-1	60	N	Ethyl acetate	100	20	N
Benzene	100	20	N	Ethylalcohol, water solution	any/96	20/60	R/M
Benzoic acid, water solution	any	20	R	Ethyl ether	100	20	N
Bleach, 12 1/2 active Cl	service conc./service conc.	40/60	R/M	Ethylene, gaseous + liquid	100	20	R
Borax, water solution	dilute/dilute/saturated (k)	40/60/60	R/M/M	Ethylene oxide	100	20	N
Boric acid, water solution	dilute/dilute/saturated (k)	40/60/60	R/M/M	Fatty acids (veg & anim.)	100	60	R
Bromium, liquid	100	20	N	Ferric chloride, water solution	up to 10/up to 10/saturated (k)	40/60/60	M/R/R
Buladiene	100	20	R	Formaldehyde, water solution	up to 10/up to 10/40	40/60/60	R/M/R
Butane, gaseous and liquid	100	20	R	Formic acid	100/100	20/60	M/R
Butanol	100	20	R	Formic acid, water solution	up to 50	40	M/R
Butanol, water solution	any	60	M	Fruit juices	-	20	N
Butyl, acetate	100	20	N	Glycerol, water solution	any	60	N
Butylene, liquid	100	20	R	Glycol, water solution	10 - 100	20 - 60	N
Butyric acid	conc.	20	N	Glycocol, water solution	10	40	N
Calcium chloride, water solution	dilute/saturated (k)	40/60	R/M	Glucose, water solution	saturated	20	M
Calcium nitrate, water solution	50	40	R	Grape sugar, water solution	saturated (k)/saturated (k)	20/60	N/M
Carbonide (urea), water solution	up to 10/up to 10/33	40/60/60	R/M/R	n - Heptane	100	20	N
Carbon dioxide, dry	100	60	R	n - Hexane	100	20	N
Carbon dioxide, moist	any	40	R	Hydrobromic acid, water solution	up to 10/up to 10	40/60	N/M
Carbon dioxide, water solution at 9 bar («Carbonic acid»)	saturated	20	R	Hydrochloric acid, water solution	up to 30/up to 30	40/60 over 30/over 30	N/M N/N

1: N = Non-resistant R = Resistant M = Marginally resistant

PVC cable tray

resistance to chemical agents for PVC (continued)

The properties stated below are purely for technical information, being based on common experience as well as the average results obtained from tests carried out. They do not entail any responsibility on the part of the manufacturer.

Chemical agents	Concentration %	Temperature °C	PVC resistance ¹	Chemical agents	Concentration %	Temperature °C	PVC resistance ¹
Hydrogen chloride gas, dry + moist	any	20/60	N	Potassium nitrate, water solution	dilute/dilute/saturated (k)	40/60/60	R/M/R
Hydrogen peroxide, water solution	up to 30/up to 30	20/50	N/N	Potassium perchlorate, water solution	1/1	40/60	R/M
Hydrogen sulphide, dry	100	60	N	Potassium permanganate, water solution	up to 18	40	R
Hydrogen sulphide, water solution	saturated (v)/saturated (v)	40/60	N/M	Potassium persulphate, water solution	dilute/dilute saturated (k)/saturated (k)	40/60 40/60	R/M R/M
Hydroxylamine sulphate, water solution	up to 12	35	N	Propane, gaseous	100	20	R
Iodine, tincture	services conc	20	R	Propane, liquid	100	20	R
Lead acetate, water solution	saturated (v)/dilute dilute/saturated (k)	50/40 60/60	R/R M/R	Pyridine	100	20	N
Magnesium chloride, water solution	dilute/dilute/saturated (k)	40/60/60	R/M/R	Seawater	/	40/60	R/M
Magnesium sulphate, water solution	dilute/dilute/saturated (k)	40/60/60	R/M/R	Silicic acid, water solution	any	60	R
Maleic acid, water solution	saturated (k)/saturated (k)	40/60	R/M	Silver nitrate, water solution	up to 8/up to 8	40/60	R/M
Methyl alcohol, methanol	100/100	60/60	R/M	Soap solution in water (soap suds)	conc./conc.	20/60	R/M
Methyl ethyl ketone, MEK	100	20	N/M	Sodium benzoate, water solution	up to 10	40	R
Methylamine, water solution	32	20	M	Sodium bisulphite, water solution	dilute/dilute/saturated (k)	40/60/60	R/M/R
Methylene chloride	100	20	R	Sodium carbonate, water solution (soda)	dilute/dilute/saturated (k)	40/60/60	R/M/R
Molasses	normal	20	R	Sodium chlorate, water solution	up to 10/up to 10/saturated (k)	40/60/60	R/M/R
Nickel sulphate, water solution	dilute/dilute/saturated (k)	40/60/60	R/R/R	Sodium chloride, water solution (common salt)	dilute/dilute/saturated (k)	40/60/60	R/M/R
Nitric acid, water solution	up to 50 / 98	50/20	M/N	Sodium chloride, water solution	dilute/dilute	20/60	M/R
Nitric oxide	highly conc./highly conc.	20/60	M/N	Sodium hypochlorite, water solution	dilute	20	R
Oils, mineral (fuel, motor, lube)	100/100	20/60	R/R	Starch, water solution	any/any	40/60	R/M
Oxalic acid, water solution	dilute/dilute/saturated (k)	40/60/60	R/M/R	Stearic acid	100	60	M
Ozone	100	20	R	Sulphur dioxide	100/100	10/60	M/R
Petrol (gasoline)	100/100	20/60	R/R	Sulphur dioxide, dry	any	60	R
Petrol (gasoline)/benzene mixture	from 80/20	20	R	Sulphur dioxide, moist + water solution	50/any	50/60	R/R
Petroleum (crude oil)	100	20	R	Sulphuric acid, water solution	up to 40/up to 40 70/70 80-90/98/98	40/60 20/60 40/20/60	M/R M/R M/R
Phenol, water solution	up to 90	45	M	Sulphuric/nitric acid mixture	50/50 50/50	20/40	M/R
Phenyldiazine	100	20	N	Tallow	100	20	R
Phosgene, gaseous	100/100	20/60	R/M	Tetraethyl lead	100	20	R
Phosgene, liquid	100	20	N	Tetrahydrofuran	100	20	N
Phosphoric acid, water solution	up to 30/up to 30/40 80/80/95	40/60/60 20/60/60	R/M/R R/R/R	Toluene (tolual)	100	20	N
Phosphorus pentoxide	100	20	R	Transformer oil	100	60	R
Phosphorus trichloride	100	60	N	Triethanolamine	100	20	N
Photographic developer	service conc.	40	R	Urine	normal	40	R
Photographic fixer	service conc.	40	R	Vinegar	commercial/grade	50/60	R/M
Picric acid, water solution	1	20	R	Vinyl acetate, liquid	100	20	N
Potash lime	up to 40/up to 50 - 60	40/60/60	R/M/R	Vinyl chloride, gaseous + liquid	100	20	N
Potassium bromide, water solution	dilute/dilute/saturated (k)	40/60/60	R/M/R	Water (not ag. Dest)	100/100	40/60	R/M
Potassium carbonate, water solution	saturated (k)	60	R	Whiskey and all other spirits	service conc.	20	R
Potassium chloride, water solution	dilute/dilute/saturated (k)	40/60/60	R/M/R	Xylene (dimethylbenzene, xylol)	100	20	N
Potassium dichromate, water solution	40	20	R	Zinc chloride, water solution	dilute/saturated (k)	60/60	M/R
Potassium ferricyanide and ferrocyanide, water solution	dilute/dilute/saturated (k)	40/60/60	R/M/R				

1: N = Non-resistant R = Resistant M = Marginally resistant



BETTER CABLE MANAGEMENT



Cableaway Pty Ltd Unit 8 / 15 McPherson Road
Smeaton Grange NSW 2567
www.cableaway.com.au
sales@cableaway.com.au
1300 883 452